

# APPLICATION NOTES

AN-PT-LTE-MP-20180604



## Octa-Band Worldwide LTE Cellular Embedded SMT Antennas

P822601/P822602



### Applications:

Cellular Handsets  
Wireless Headsets  
M2M  
Automotive

Automatic Meter Reading  
Healthcare  
Point of Sale  
Tracking

Smart Applications  
Tablets and Notebooks  
Other Wireless  
Devices

PDAs Notebook PCs  
Industrial Devices  
Media Player

# Octa-Band Worldwide LTE Cellular Embedded SMT Antennas



## Table of Contents

---

• <b>Purpose</b> .....	<b>2</b>
• <b>Overview</b> .....	<b>2</b>
• The Prestta LTE Product Line .....	2
• Difference between P822601 and P822602 .....	2
• Product Selection Guide .....	2
• IMD Technology Advantages.....	3
• <b>Design Guidelines</b> .....	<b>4</b>
• Introduction .....	4
• Electrical Specifications .....	4
• Mechanical Specifications.....	4
• Antenna Layout.....	4
• Antenna Footprints.....	7
• Antenna Location .....	7
• Matching Networks.....	8
• Measured Data.....	9
• Antenna Tuning Guidelines.....	11
• MIMO Antenna Location Recommendation .....	18
• <b>Material Specifications</b> .....	<b>21</b>
• <b>Manufacturing and Assembly Guidelines</b> .....	<b>21</b>
• Component Handling Recommendations .....	21
• Paste Stencil Recommendation .....	22
• Soldering Recommendations .....	22
• Additional Manufacturing Recommendations.....	22
• Cleaning Recommendations.....	22
• Rework & Removal Recommendations .....	22
• Tape & Reel Specifications .....	22

### RESTRICTED PROPRIETARY INFORMATION

The information disclosed herein is the exclusive property of KYOCERA AVX Components Corporation and is not to be disclosed without the written consent of KYOCERA AVX Components Corporation. No part of this publication may be reproduced or transmitted in any form or by any means including electronic storage, reproduction, execution or transmission without the prior written consent of KYOCERA AVX Components Corporation. The recipient of this document by its retention and use agrees to respect the security status of the information contained herein. KYOCERA AVX may make changes to specifications and product descriptions at any time, without notice.

KYOCERA AVX Components Corporation assumes no responsibility or liability for any errors or inaccuracies that may appear in this document.

Copies of documents that are referenced in this document or other KYOCERA AVX literature may be obtained by calling +1 (864) 967-2150, email at [Inquiry@kyocera-avx.com](mailto:Inquiry@kyocera-avx.com) or the website [www.kyocera-avx.com](http://www.kyocera-avx.com).

Contact your local sales office or manufacturers' representative to obtain the latest specifications.

© 2022 KYOCERA AVX. All rights reserved. The KYOCERA AVX logo, Isolated Magnetic Dipole and Savvi are trademarks of KYOCERA AVX. All other trademarks are the property of their respective owners. Product specifications subject to change without notice.

# Prestta™ Octa-Band LTE/Cellular SMT Antennas

## Purpose

This document provides information for incorporating KYOCERA AVX'S Prestta standard embedded LTE Cellular antenna into wireless products. Specifications, design recommendations, board layout, packaging and manufacturing recommendations are included.

This document is divided into two parts: a main section and appendices. The main section addresses points and issues common to all products. The appendices provide product-specific information.

## Overview

### The Prestta LTE Product Line

The Prestta Standard Octa-Band LTE Cellular antenna, listed below, represents a new category of internal IMD antennas. KYOCERA AVX antennas utilize proprietary and patented Isolated Magnetic Dipole (IMD) technology to meet the needs of device designers for higher performance; providing greater than 65% average efficiency across a very wide band covers all LTE and Cellular bands (700MHz, 850MHz, 900MHz, 1800MHz, 1900MHz, 2100MHz, and 2700MHz). Standard, off-the-shelf, antennas lower total costs, enable quicker time to market and work with a variety of designs.

### Difference between P822601 and P822602

The two LTE antennas P822601 and P822602 are using the same design and same dimensions. P822602 is the mirrored antenna of P822601, which should have same performance as P822601.

Using the mirrored version P822602 or the original P822601 will be defined depending on the preferred location for the antenna feed on your board.

### Product Selection Guide

Antenna PN	Application	Antenna PN Application Type Typical Deliverable	Typical Deliverable Size
P822601/P822602	<ul style="list-style-type: none"> <li>• 700 MHz</li> <li>• 850, 900 MHz</li> <li>• 1800, 1900 MHz</li> <li>• 2100 MHz</li> <li>• 2600 MHz</li> </ul>	<ul style="list-style-type: none"> <li>• Partial Ground</li> <li>• Flexible antenna placement</li> </ul>	<ul style="list-style-type: none"> <li>• SMT mountable antenna assembly</li> <li>• 49.6 x 8.0 x 3.2 mm</li> </ul>
P822601-01/P822602-01	<ul style="list-style-type: none"> <li>• 700 MHz</li> <li>• 850, 900 MHz</li> <li>• 1800, 1900 MHz</li> <li>• 2100 MHz</li> <li>• 2600 MHz</li> </ul>	<ul style="list-style-type: none"> <li>• Demo Board</li> </ul>	<ul style="list-style-type: none"> <li>• Antenna Assembly on PCB board</li> <li>• 50 x 140 mm</li> </ul>

Additional antennas are under development, please see KYOCERA AVX'S Website, or ask Ethertronics sales person about additional products to meet your needs.

# Prestta™ Octa-Band LTE/Cellular SMT Antennas



→ Figure 1 ←

## IMD Technology Advantages

### Real-World Performance and Implementation

Other antennas may contain simple PIFA or monopole designs that interact with their surroundings, complicating layout or changing performance with user position. KYOCERA AVX'S antennas utilize patented IMD technology to deliver a unique size and performance combination.

### Stays in Tune

IMD technology provides superior RF field containment, so antennas resist de-tuning to provide a robust radio link regardless of the usage position. Other antennas may experience substantial frequency shifts and lowered performance, when held by users or placed next to the head.

### Smallest Effective Size

Unlike antennas using other technologies, IMD antennas require minimal ground clearance and keep-out areas for surrounding components. This can lead to a smaller "effective" size when all factors are taken into account. In addition to an ultra-thin, end-user device designs

### IMD Technology: How it works

IMD technology uses confinement of the electrical field to create the antenna's mode. The strongly confined antenna mode reduces its coupling to the surrounding environment. The diagram to the right shows the electrical field created on the PCB ground plane for an KYOCERA AVX IMD antenna and a PIFA (Planar Inverted F Antenna). Red areas indicate the highest current while blue areas signify the lowest. As demonstrated, currents from the IMD design are highly localized, while high currents are observed all the way over to the ground plane edge on the PIFA.

KYOCERA AVX'S IMD antennas are ideally suited for wireless data devices, where performance, size and system costs are critical. The surface mount design and compact size are suited for high volume applications. Standard antenna profiles are available or can be configured to suit individual OEM requirements.

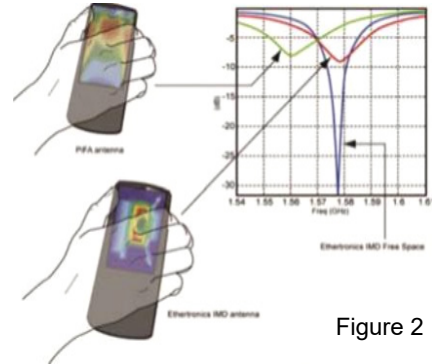
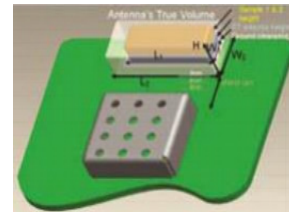
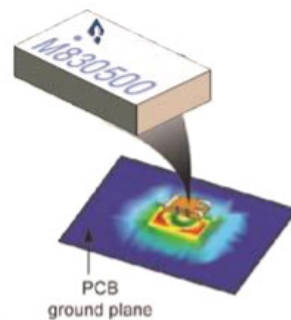

Figure 2



### Ethertronics IMD antenna

- Currents confined to element
- Energy maintained, higher efficiency
- Minimal keep out area



PCB ground plane

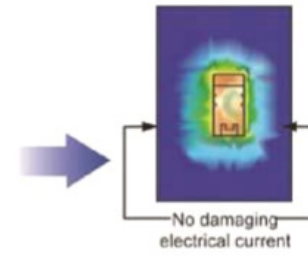

No damaging electrical current



### PIFA antenna

- Currents flow on PCB
- Energy lost, lower efficiency
- Large keep out area

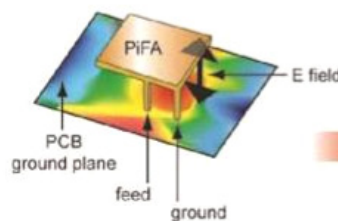

PCB ground plane  
feed  
ground

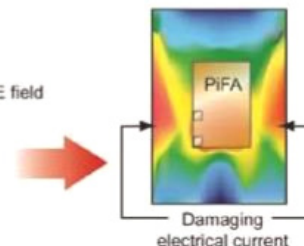

Damaging electrical current

Figure 5

# Prestta™ Octa-Band LTE/Cellular SMT Antennas

## Prestta Standard P822601/P822602 LTE Cellular Antenna Features and Benefits Summary

Feature	Advantage
LTE Cellular	<ul style="list-style-type: none"> <li>Eliminates external antennas</li> </ul>
High Performance Embedded Solution	<ul style="list-style-type: none"> <li>Greater than 65% average efficiency across all brands</li> </ul>
Extensive design collateral and apps support	<ul style="list-style-type: none"> <li>Speeds development time</li> </ul>
Standard "Off-the-Shelf" Product	<ul style="list-style-type: none"> <li>Speeds development time and reduces costs since reduces NRE and custom development time</li> </ul>
Smaller Form Factor & Ground Clearance Requirements	<ul style="list-style-type: none"> <li>Can be used in a variety of custom form factors and applications</li> </ul>

## Design Guidelines

### Introduction

The Prestta Octa-Band Embedded LTE Cellular Antenna can be designed into many wireless product types. The following sections explain KYOCERA AVX'S recommended layouts to help the designer integrate the antennas into a product with optimum performance.

### Electrical Specifications

Typical Characteristics Measurement taken with a matching circuit on a 50 x 140 mm ground plane.

LTE Cellular Antenna	700-746	746-787	824-894	880-960	1710-1880	1850-1990	1920-2170	2500-2700
Peak Gain	dBi	dBi	dBi	dBi	dBi	dBi	dBi	dBi
Average Efficiency	58.2%	73.7%	70.7%	71.6%	80.0%	70.4%	73.9%	52.7%
VSWR Match	VSWR<2.5:1 over the whole frequency range							
Feed Point Impedance	50 ohms unbalanced (other if required)							
Power Handling	2-Watt cw							
Polarization	Linear							

### Mechanical Specifications

Maximum Dimensions	49.6 x 8.0 x 3.2
Mechanical Mounting	Antenna Assembly is SMT attached to main PCB.
RF Mounting	RF and Ground feed pads are SMT attached to main PCB.

### Antenna Layout

Figure 1 below shows the Prestta Standard Octa-Band LTE Cellular Antenna layout for P822601

Figure 2 below shows the Prestta Standard Octa-Band LTE Cellular Antenna layout for P822602

- **Maximum Dimensions:** 49.6 x 8.0 x 3.2 mm
- **RF Mounting:** RF Feed and Ground pads are SMT attached to the main PCB
- **Mechanical Mounting:** Antenna Assembly is SMT attached to the main PCB

# Prestta™ Octa-Band LTE/Cellular SMT Antennas

## Antenna Layout for P822601

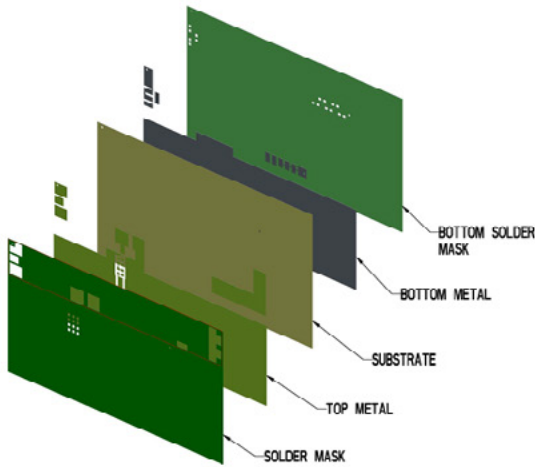

- Additional VIAS: Diam. 0.2mm to be placed around antenna, (no vias on transmission lines).
- Via holes must be covered by solder mask

### Pin Descriptions

Pin#	Description
1	Feed
2	Ground
3	Dummy Pad
4	Low Band Tuning
5	High Band Tuning
6	Dummy Pad
7	Dummy Pad

\*P822602 uses the same layout but mirrored.

Default Pi Matching Network values with instructions can be found under Antenna Matching Network.

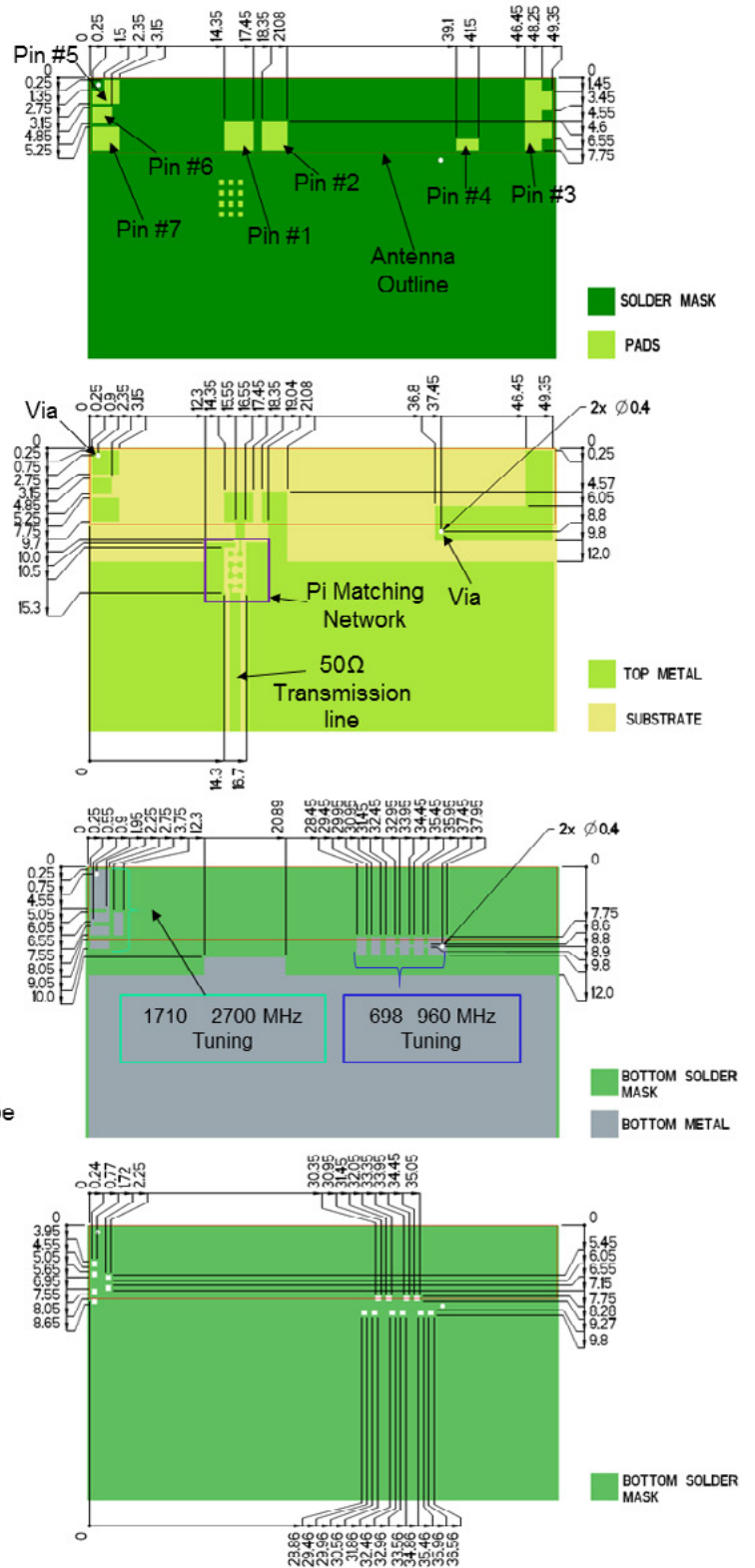
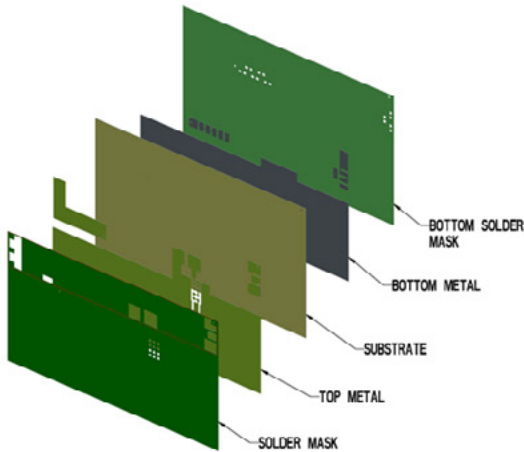

Figure 1: Antenna Layout for P822601



# Prestta™ Octa-Band LTE/Cellular SMT Antennas

## Antenna Layout for P822602



- Additional VIAS : Diam. 0.2mm to be placed around antenna, (no vias on transmission lines).
- Via holes must be covered by solder mask

### Pin Descriptions

Pin#	Description
1	Feed
2	Ground
3	Dummy Pad
4	Low Band Tuning
5	High Band Tuning
6	Dummy Pad
7	Dummy Pad

\*P822601 uses the same layout but mirrored.

Default Pi Matching Network values with instructions can be found under Antenna Matching Structure.

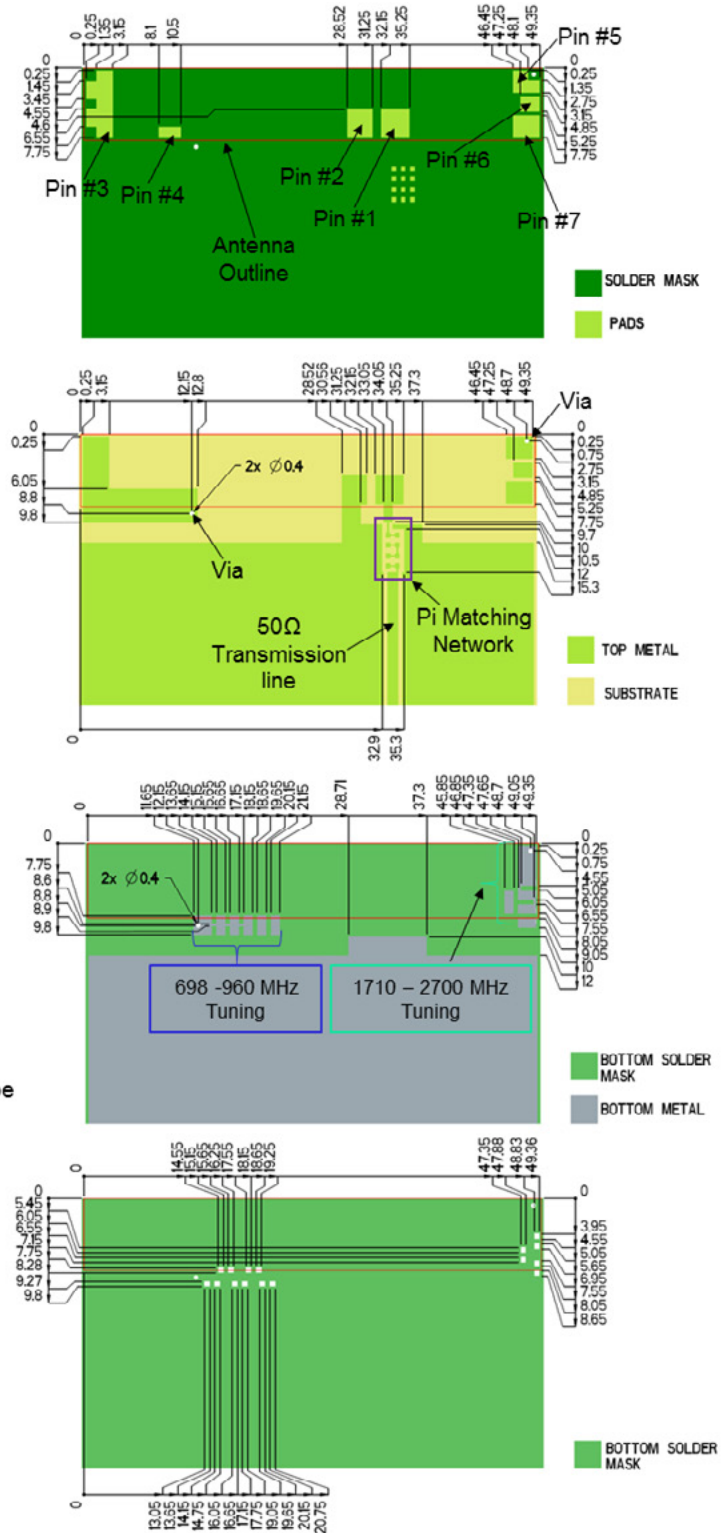

Figure 1: Antenna Layout for P822602

# Prestta™ Octa-Band LTE/Cellular SMT Antennas

## Antenna Footprints

The Prestta Octa-Band Embedded LTE Cellular Antenna can be designed into many wireless product types. The following sections explain KYOCERA AVX'S recommended layouts to help the designer integrate the antennas into a product with optimum performance.

## Antenna Location

Figure 3 shows P822601 and P822602 typical landing location of a Prestta Octa-Band Embedded Cellular Antenna.





# Prestta™ Octa-Band LTE/Cellular SMT Antennas

## Matching Networks

Figure 4 below shows the Matching Circuit. The default Components used on ET demo board are listed below:

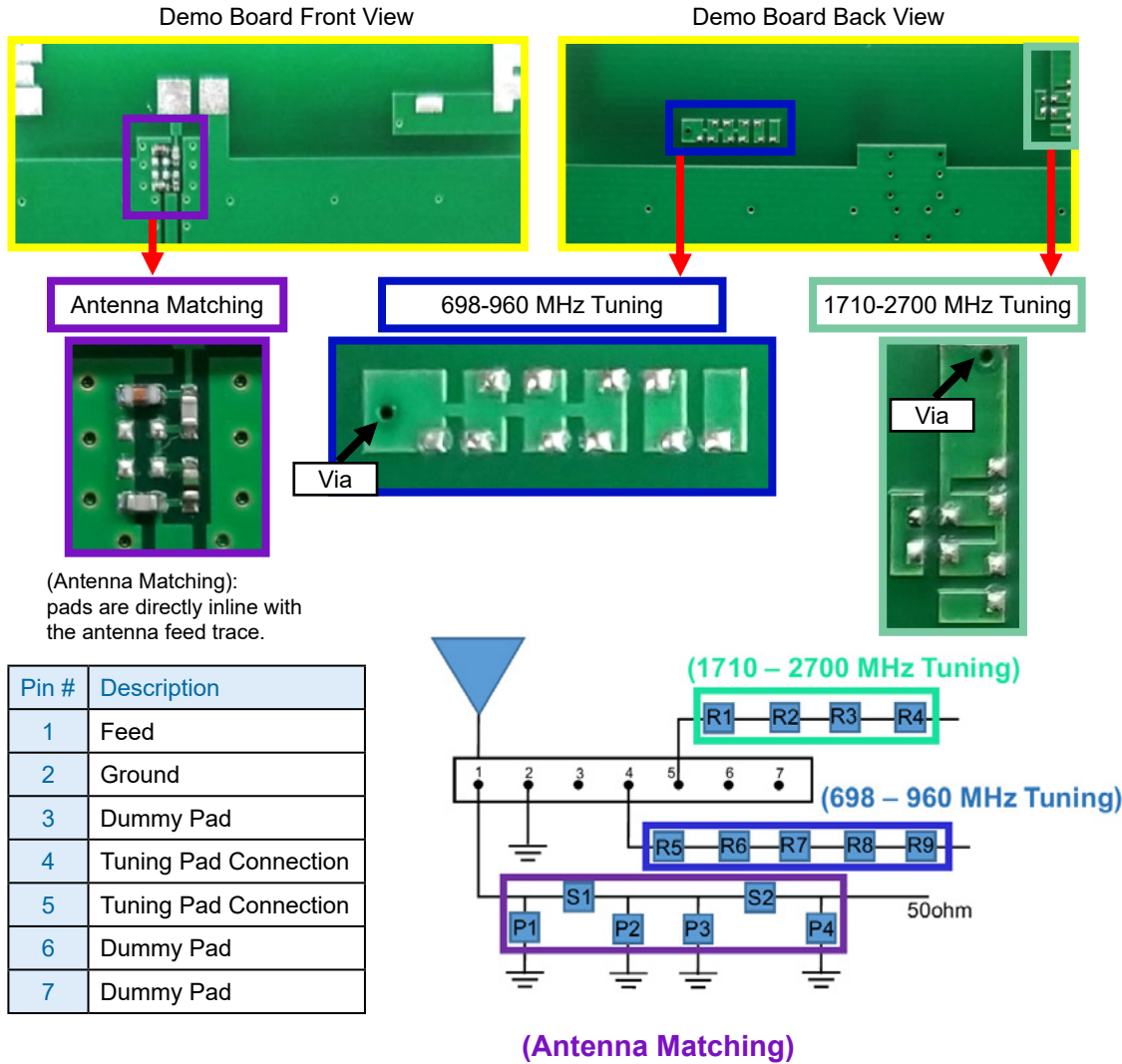

\*P822601 and P822602 uses same default matching values

	P1	S1	P2	P3	S2	P4	R1-R4	R5-R9
<b>Default Matching</b>	27nH	2.4pF	DNI	DNI	1.0nH	0.3pF	DNI	DNI
<b>Recommended Components</b>	AVX HL02270G TTR	AVX 04025J2R4 ABSTR	N/A	N/A	AVX L04021R0 AHNTR	AVX 04023J0R3 ABSTR	N/A	N/A

Figure 4: Antenna Matching Circuit

Product specifications subject to change without notice

# Prestta™ Octa-Band LTE/Cellular SMT Antennas

## Measured Data

### VSWR and Efficiency

Below are the typical performances using KYOCERA AVX standard demo-board P822601-01. Performances will be similar for the P822602-01

**Low Band VSWR**

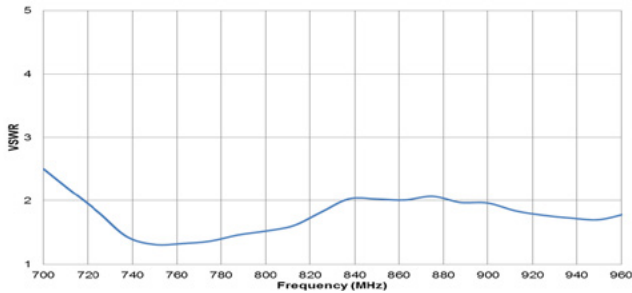

**Low Band Efficiency**

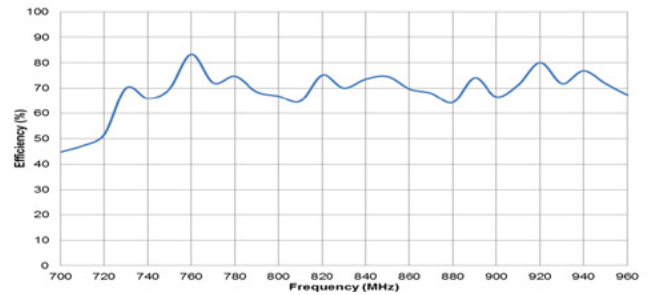

**High Band VSWR**

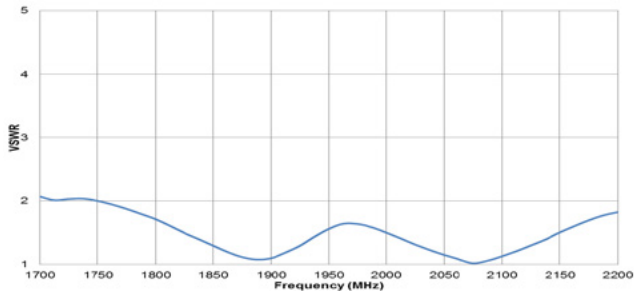

**High Band Efficiency**

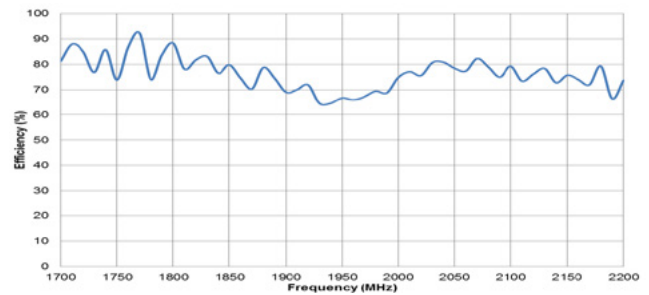

**High High Band VSWR**

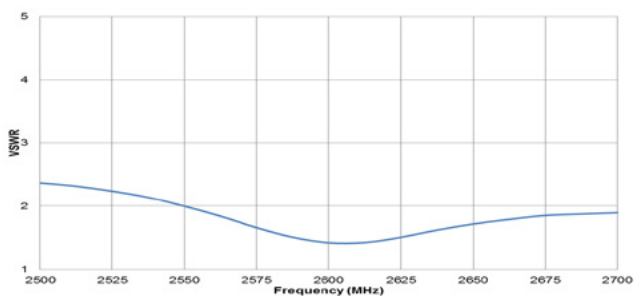

**High High Band Efficiency**

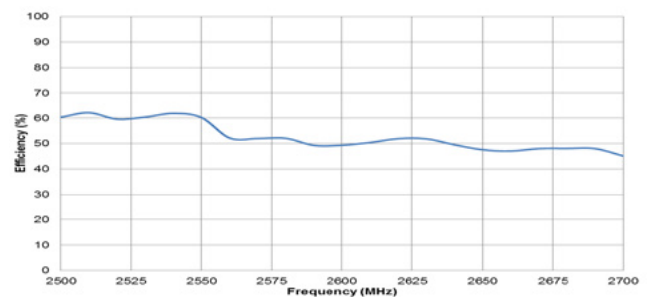

Product specifications subject to change without notice.

# Prestta™ Octa-Band LTE/Cellular SMT Antennas

## Radiation Patterns

Figure 1 represents the test setup using KYOCERA AVX standard demo-board P822601-01. The typical performance are similar for the P822692-01

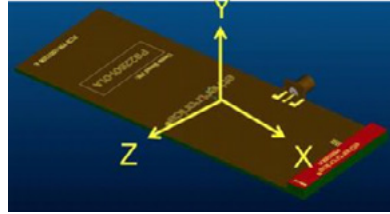
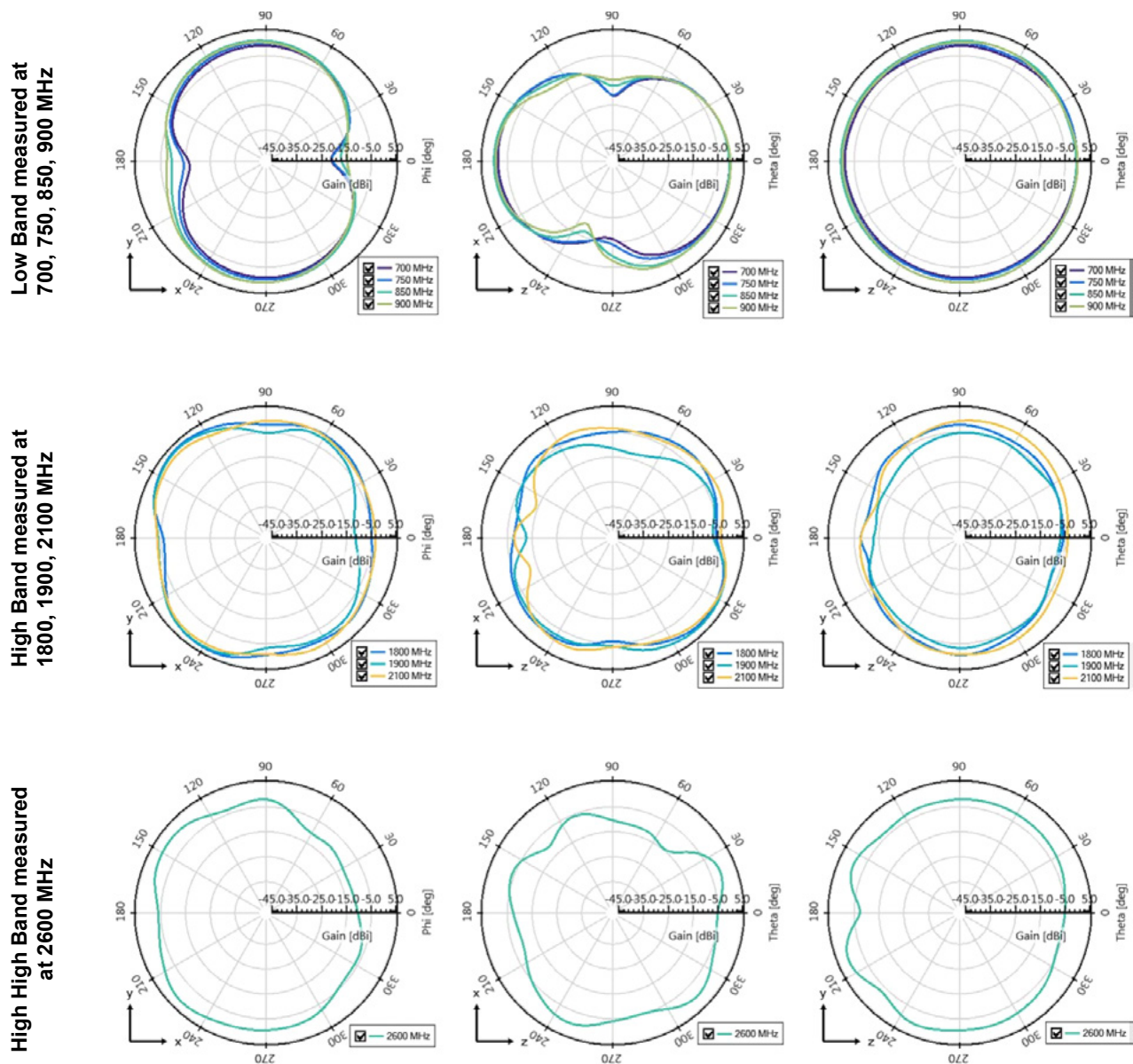

Figure 1: Test Setup



Product specifications subject to change without notice.

# Prestta™ Octa-Band LTE/Cellular SMT Antennas

## Antenna Tuning Guidelines

All tunings are done through the PCB layout or matching circuit value. There are four ways to tune the antenna using the PCB layout:

- Major tuning through the tuning pad printed on the PCB
- Minor tuning through the matching network
- Change of the antenna location and varying board size
- Change on the ground clearance area

### Major Tuning Through the Tuning Pad Printed on the PCB

A common effect of shield cans, housing and other close by components on the antenna performances is frequency shift. To offset the detuning effect, the PCB includes printed Tuning Pad. The low band tuning pads mainly control the 2nd frequency mode of low band and high band tuning pads impact the 2nd frequency mode of high band. The general control rule is that the larger number of tuning pads are connected, the lower the is frequency shifted.

Figure 1 represents the tuning pads on the back of the antenna footprints.

Table 1 defines the Low band (698-960 MHz) tuning configurations

Table 2 defines the High band (1710-2700 MHz) tunings configurations

Figure 2 plots the return loss variations based on the different tuning configurations

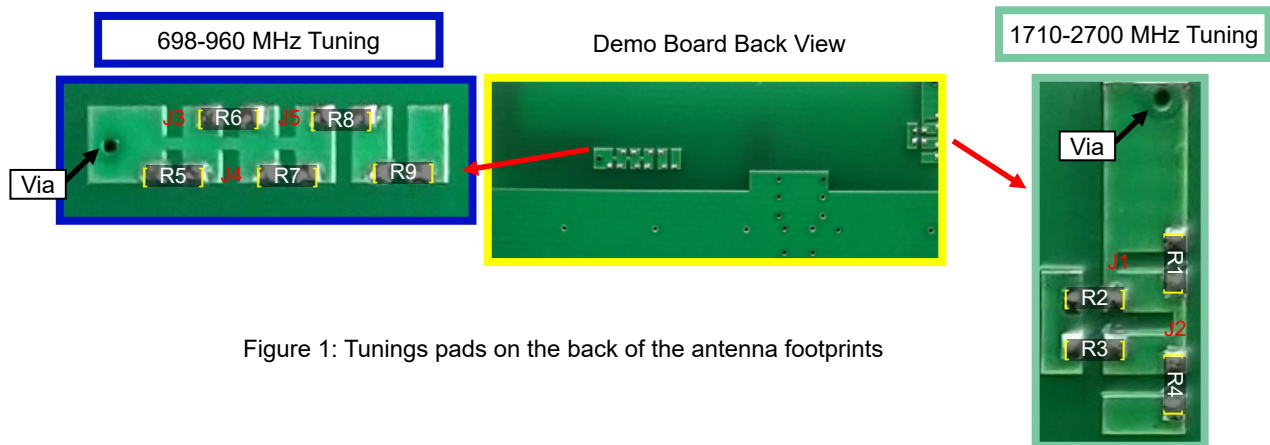

Figure 1: Tunings pads on the back of the antenna footprints

Tuning Pad Length	J3	J4	J5	R5	R6	R7	R8	R9
LB Pad Length 1	Joint	Cut	Joint	N/A	N/A	N/A	N/A	N/A
LB Pad Length 2	Joint	Joint	Cut	N/A	N/A	N/A	N/A	N/A
LB Pad Length 3	Joint	Joint	Joint	N/A	N/A	N/A	N/A	N/A
LB Pad Length 4	Joint	Joint	Joint	N/A	N/A	N/A	0ohm	N/A
LB Pad Length 5	Joint	Joint	Joint	N/A	N/A	N/A	0ohm	0ohm

Table 1: Low Band 698-960 MHz Tuning Pad Configurations

# Presta™ Octa-Band LTE/Cellular SMT Antennas

Tuning Pad Length	J1	J2	R1	R2	R3	R4
HB Pad Length 1	Cut	Joint	N/A	N/A	N/A	N/A
HB Pad Length 2	Joint	Cut	N/A	N/A	N/A	N/A
HB Pad Length 3	Joint	Joint	N/A	N/A	N/A	N/A
HB Pad Length 4	Joint	Joint	N/A	N/A	0ohm	N/A
HB Pad Length 5	Joint	Joint	N/A	N/A	N/A	0ohm

Table 2: High Band 1710-2700 MHz Tuning Pad Configurations

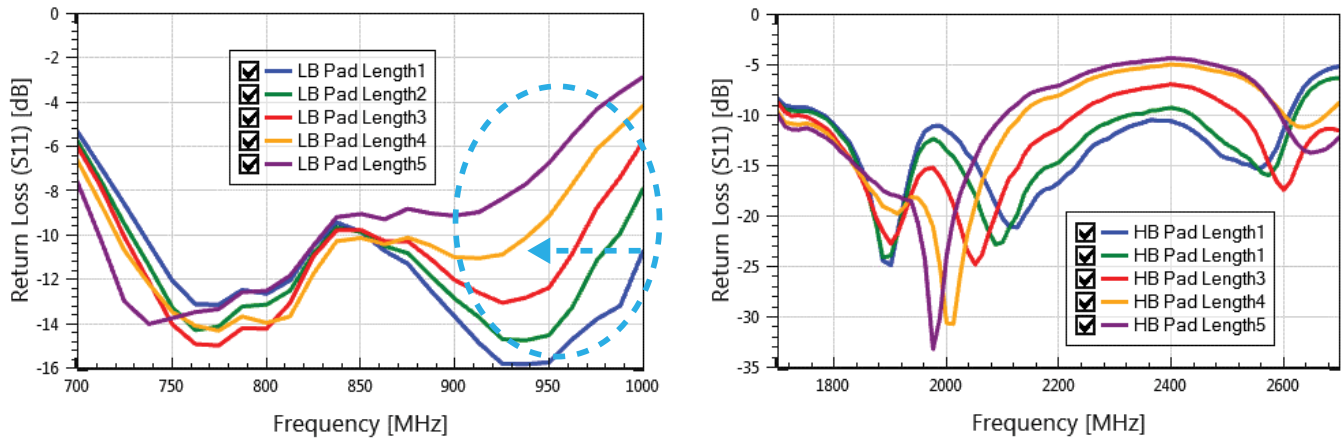

Figure 2: Return loss variations based on the different tuning configurations

### Matching Circuit Tuning Guidelines

Performance can be also improved by tuning the matching circuit. In general, low band resonance is mainly affected by P1 and S1, while high band resonance is affected by S2 and P4. By adjusting the value of matching components, it is possible to control slight resonance shift and optimize coupling between neighbor resonances. Optimum matching values may vary with different boards transmission line design and antenna working environments. The following page shows the Return Loss variation with different matching value of each component using KYOCERA AVX 140mm x 50mm demo board P822601-01 or P822602-01.

Figure 1 represents the matching circuit on the front of the antenna footprints.  
Figure 2 and 3 plots the return loss variations based on the different matching values

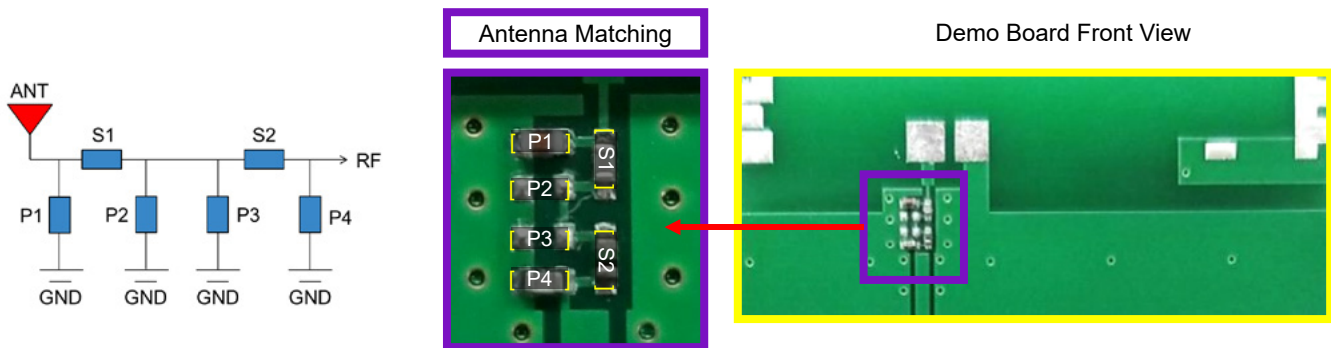

Figure 1: Matching circuit on the front of the antenna footprints

Product specifications subject to change without notice.



# Prestta™ Octa-Band LTE/Cellular SMT Antennas

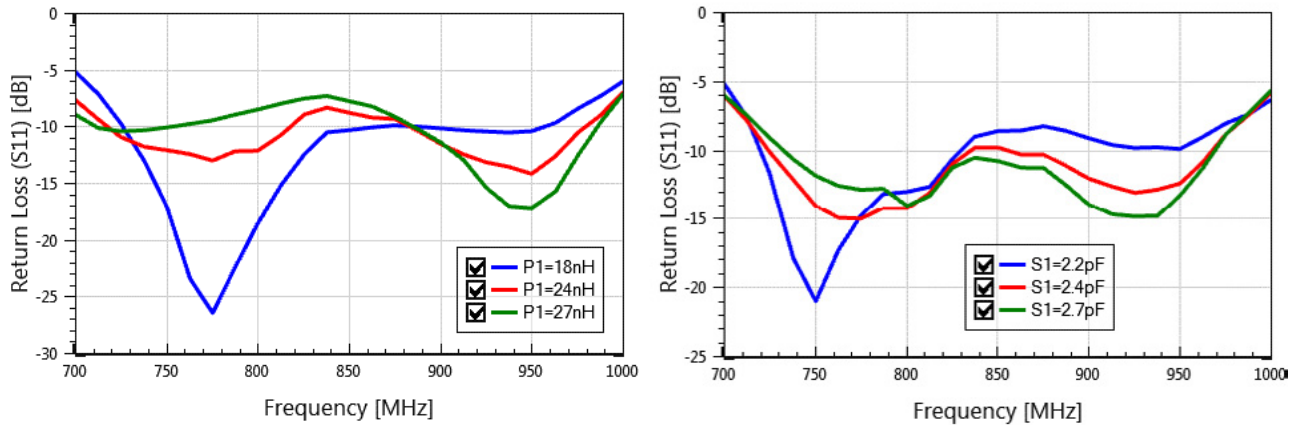

Figure 2: Return loss variations based on the different tuning configurations

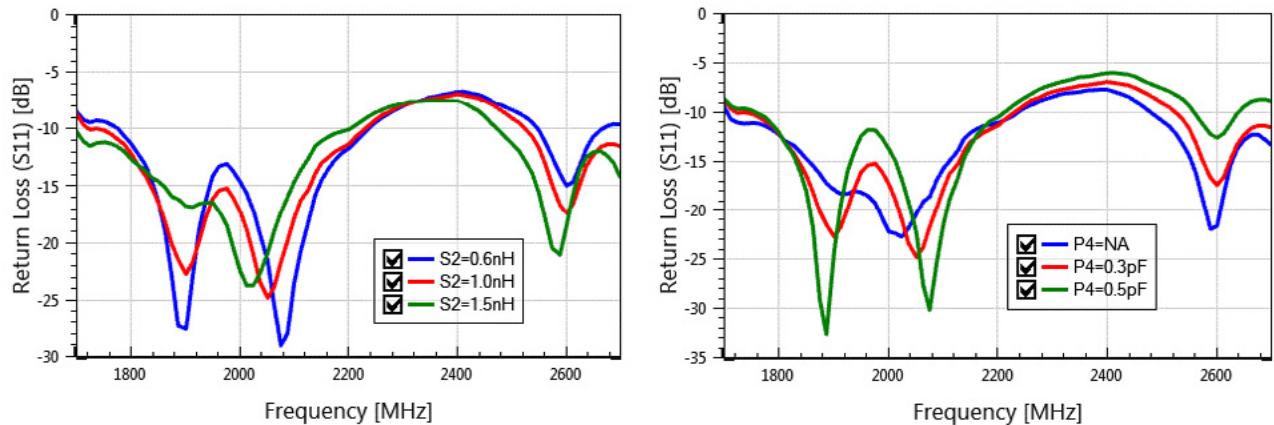

Figure 2: Return loss variations based on the different tuning configurations

## Change of Antenna Location and Variation in Board Size

The board size and antenna location are the most important factor for antenna performance. The ideal PCB size is 140x50mm. In general, the smaller the board size, the lower the low band performance will be. Nevertheless, antenna performance can be improved by modifying the tuning pad and optimizing the matching components accordingly. Here are some studies to help identifying the best antenna location in different board sizes and shapes configuration.

### Study 1: Antenna performance variation using different PCB length.

The optimum PCB length is 140mm, this is especially true for the low band performances. Antenna performances may degrade if the PCB is shorter or longer. KYOCERA AVX recommends using a PCB length is too short, and high bandwidth will become narrow if the PCB length is too long

**Study 2:** Antenna performance variation with different PCB width in different sides of the board. Antenna performance may degrade if additional ground is added in either side of the board. Adding ground on the left-side impacts the high band performance while extra ground on the right-side impacts the low band.

**Study 3:** Antenna performance variation based on antenna location in large PCB. If both width and length of the PCB exceed 140mm, the preferred antenna location is changed to the right corner of the PCB.

**Study 4:** Antenna performance variation with different ground extension positions based on a short PCB. When using a short PCB (<100mm), the main challenge is to get good performance at low band. However, a certain length of ground extension may help improve the performance. Through the investigation, the best position for the ground extension is the bottom edge. If there is not enough space in the PCB length direction, consider growing the ground plane on the vertical side from the bottom edge. The second option is to extend the ground horizontally from the right side edge of the PCB.

Product specifications subject to change without notice.



# Prestta™ Octa-Band LTE/Cellular SMT Antennas

## Study 1: Antenna performance variation using different PCB length

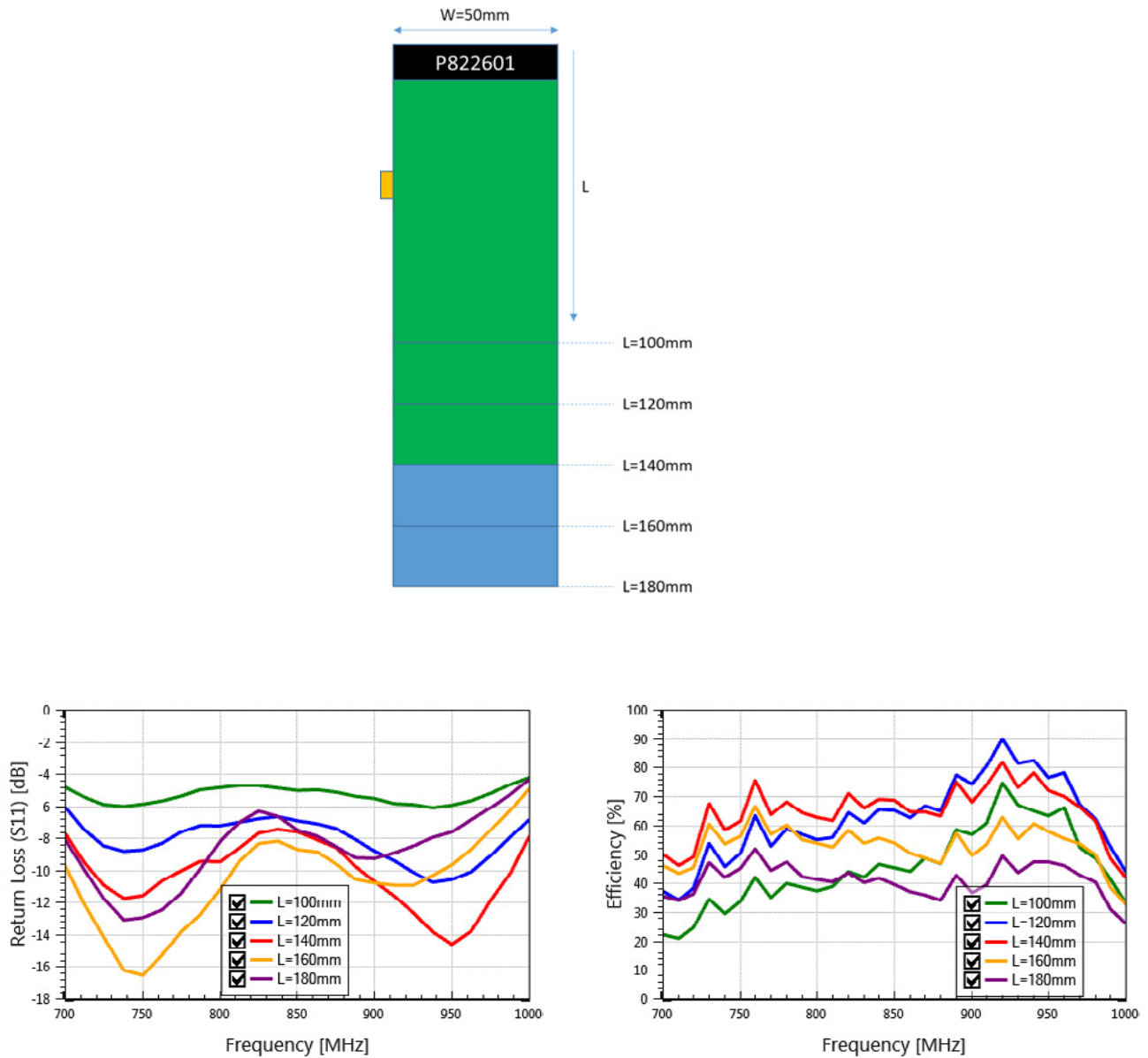

Figure 1: Low band return loss and efficiency variation based on Study 1

Product specifications subject to change without notice.

# Prestta™ Octa-Band LTE/Cellular SMT Antennas

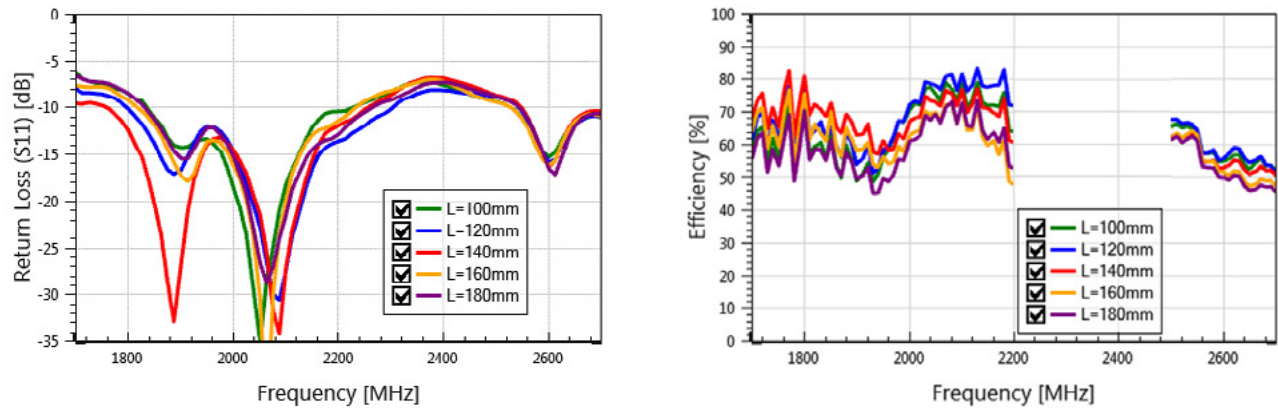

Figure 2: High band return loss and efficiency variation based on Study 1

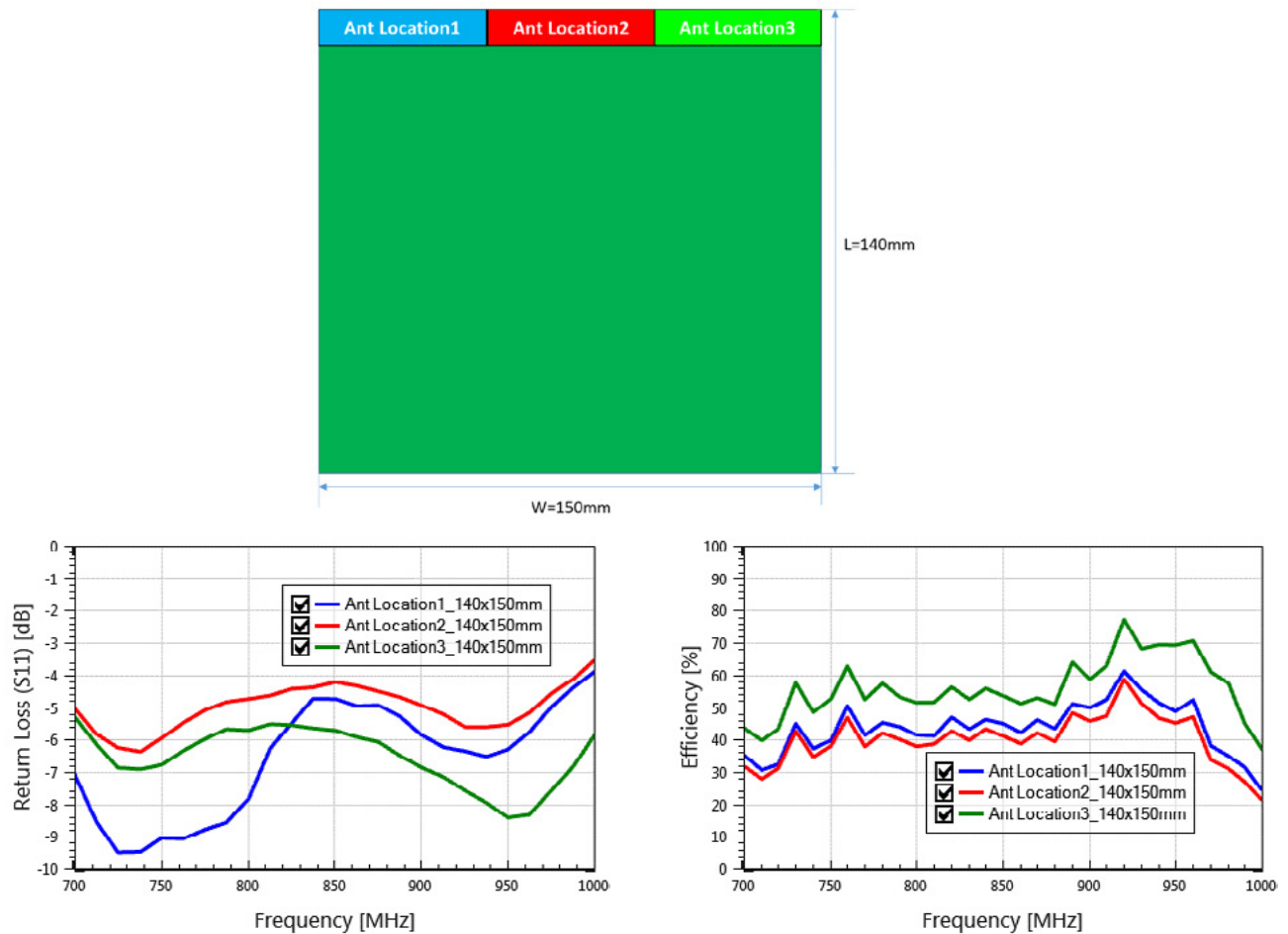

Figure 1: Low band return loss and efficiency variation based on Study 3

Product specifications subject to change without notice.

# Prestta™ Octa-Band LTE/Cellular SMT Antennas

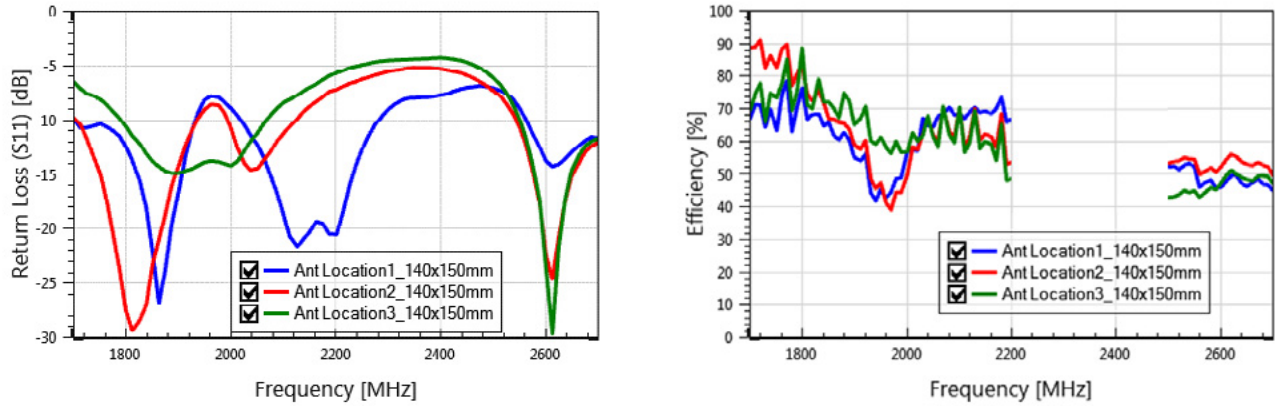

Figure 2: High band return loss and efficiency variation based on Study 3

## Study 4: Antenna performance variation with different ground extension positions based on a short PCB

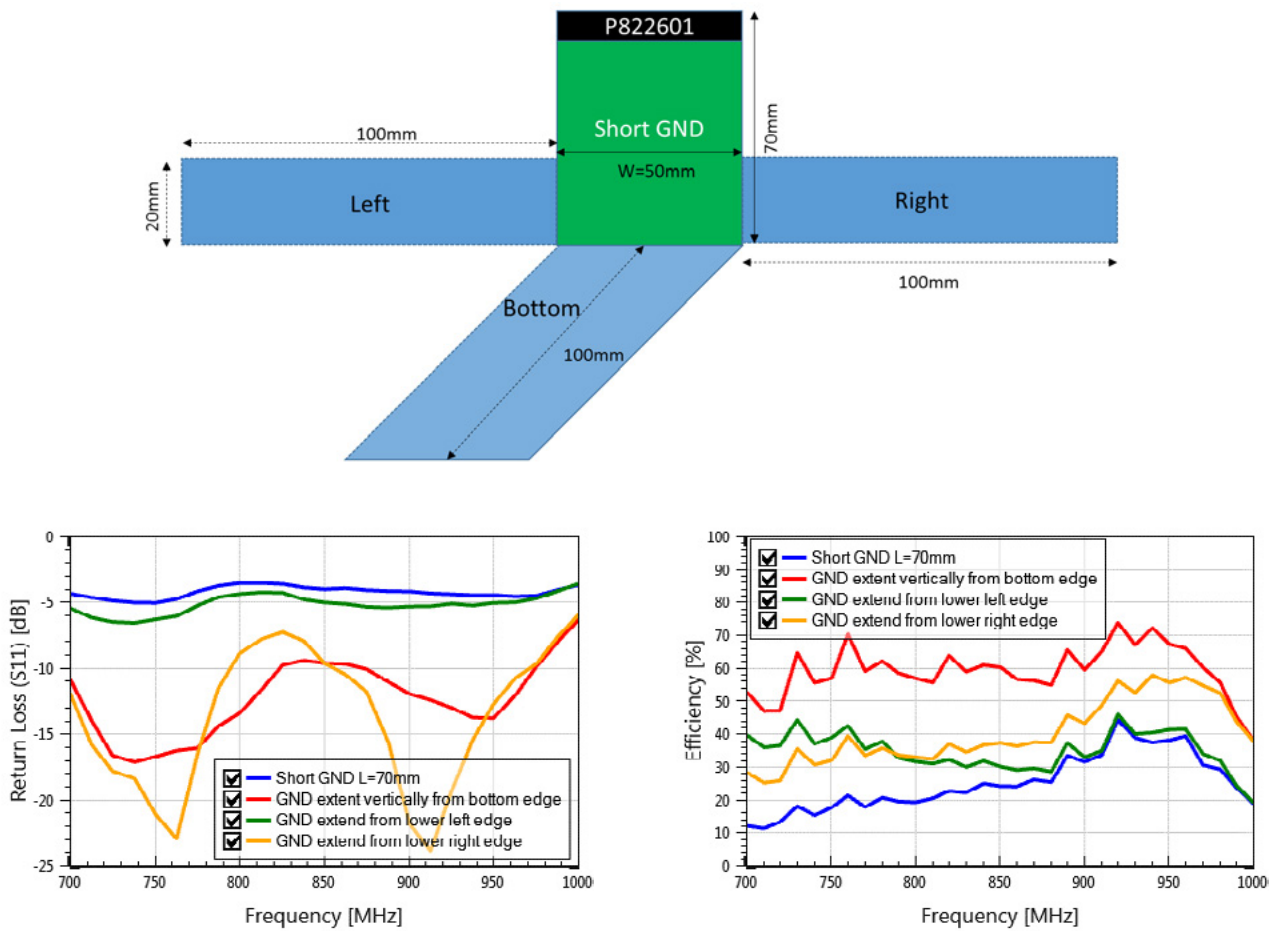

Figure 1: Low band return loss and efficiency variation based on Study 4

Product specifications subject to change without notice.

# Prestta™ Octa-Band LTE/Cellular SMT Antennas

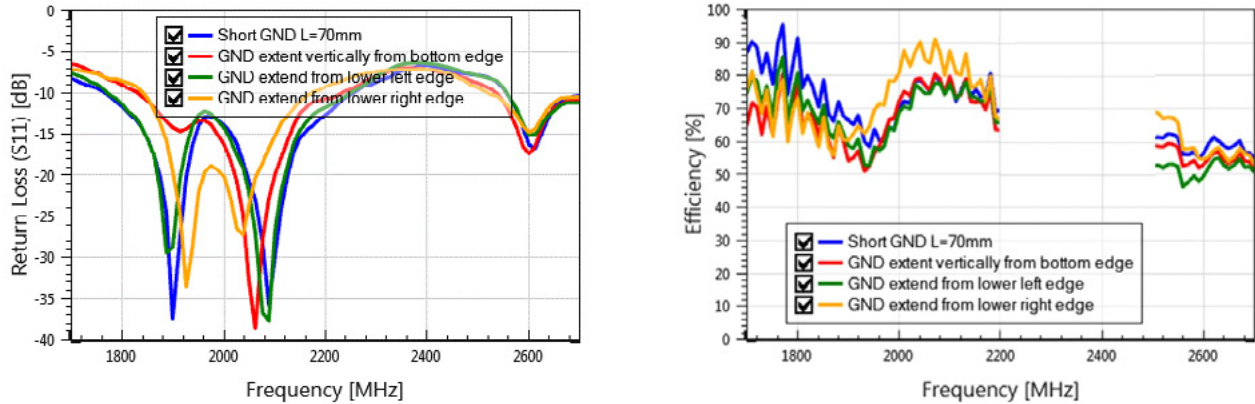

Figure 2: High band return loss and efficiency variation based on Study 4

## Change on the Ground Clearance Area

The default antenna ground clearance is 12mm from the top edge. It is preferred to remove all the ground above the 12mm line. However, in many cases, in order to further optimize antenna performance, one or two additional rectangular notches at antenna sides will be needed (shown in gray in the picture below).

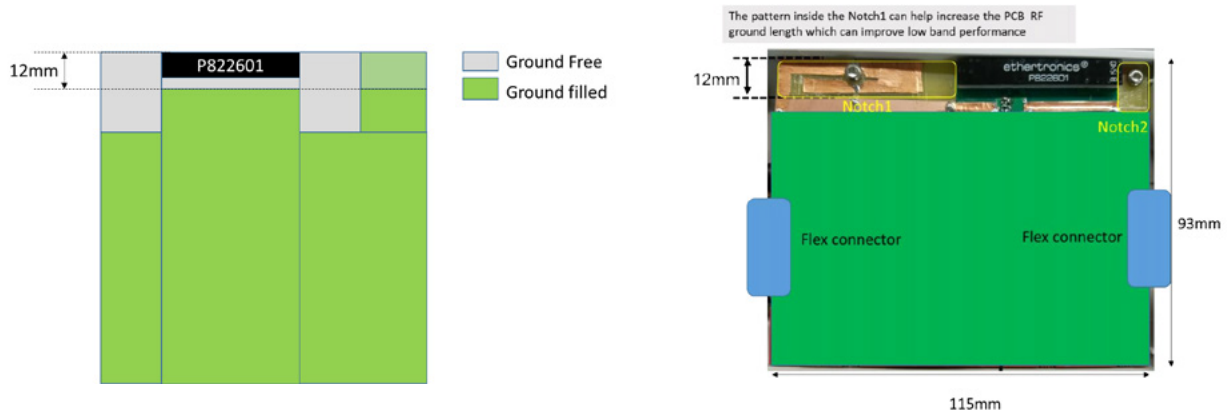

Figure 1: Left represents the recommended ground clearance with notches  
Right displays a test example with added pattern on the notch

If the Antenna board is located above another ground plane (like another PCB, a big metal plate or a LCD), make sure that the antenna and the 12mm footprint clearance portion is cleared out off the bottom ground. There will be two cases:

1. The antenna PCB ground is too small to offer optimum antenna performance:  
In this case, the bottom ground may be used to help increase the antenna RF ground size and optimize the antenna performance (see the left side picture below). The two PCB grounds needs to be connected by a grounded screw or conductive foam.
2. The Antenna PCB ground is optimized based on antenna requirements:  
If the bottom ground is large and can impact the antenna performance (see the right side picture below), increase the space by approximately 5mm or more between the two ground planes to help reduce the bottom ground impact.

Product specifications subject to change without notice.

# Prestta™ Octa-Band LTE/Cellular SMT Antennas

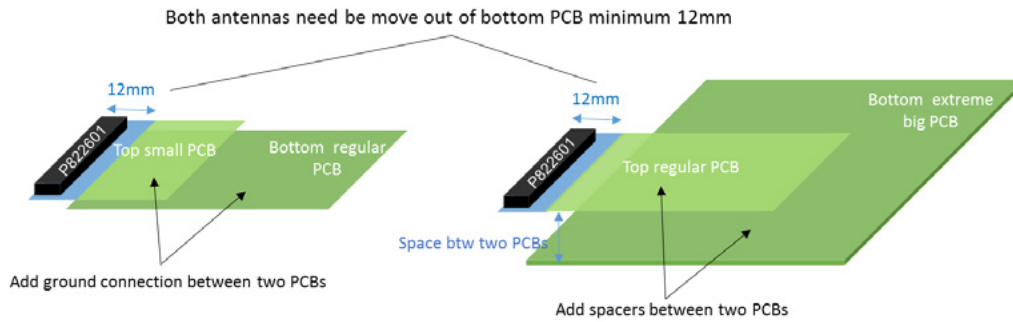

Figure 2: Ground clearance when the antenna is on top of a second ground

## MIMO Antenna Location Recommendation

The MIMO technology requires that both LTE antennas have high performance (which is different from Main/Diversity design where Diversity have lower performance requirement).

Below are recommended MIMO antennas placements based on two different test conditions:

- Antennas placed on the same edge of board
- Antennas placed in parallel at opposite edge of the board

### Antennas Placed on the Same Edge of the Board

- The board solution, both two LTE antennas can have similar performance and offer good isolation. The two LTE recommended location are in the two opposite corners of the long edge using mirrored antennas (P822601 at right corner and P822602 at the left) with a notch (or isolator) between them (see the Test Example 1 and Example 2 below).
- The notch width can impact the antenna isolation, in general, the wider the notch, the better the isolation; Notch depth can impact high band performance. A deeper notch is preferred for higher antenna performance. The minimum recommended Notch depth is 12mm, which is similar to the antenna footprint ground clearance.
- When P82260X antennas are placed on the same edge, antenna high band portion should be towards the inside of the board and the low band portion toward the outside. As a result, the P822601 is better suited to be at the right corner and the P822602 at the left.

Below are 2 test setups where the antennas are at the edge of the boards, first on a square board, then on a rectangular board.

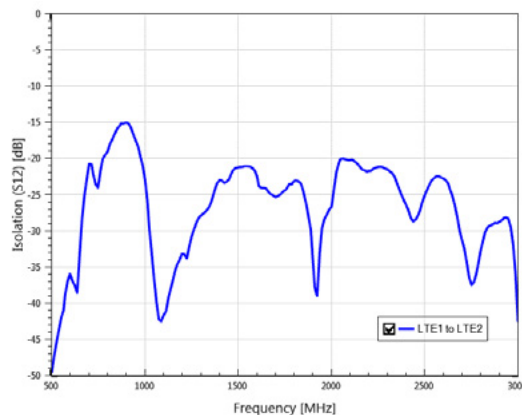
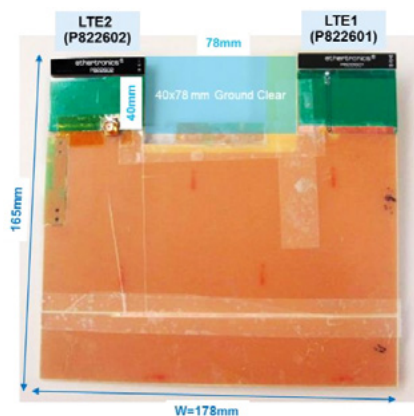



# Presta™ Octa-Band LTE/Cellular SMT Antennas

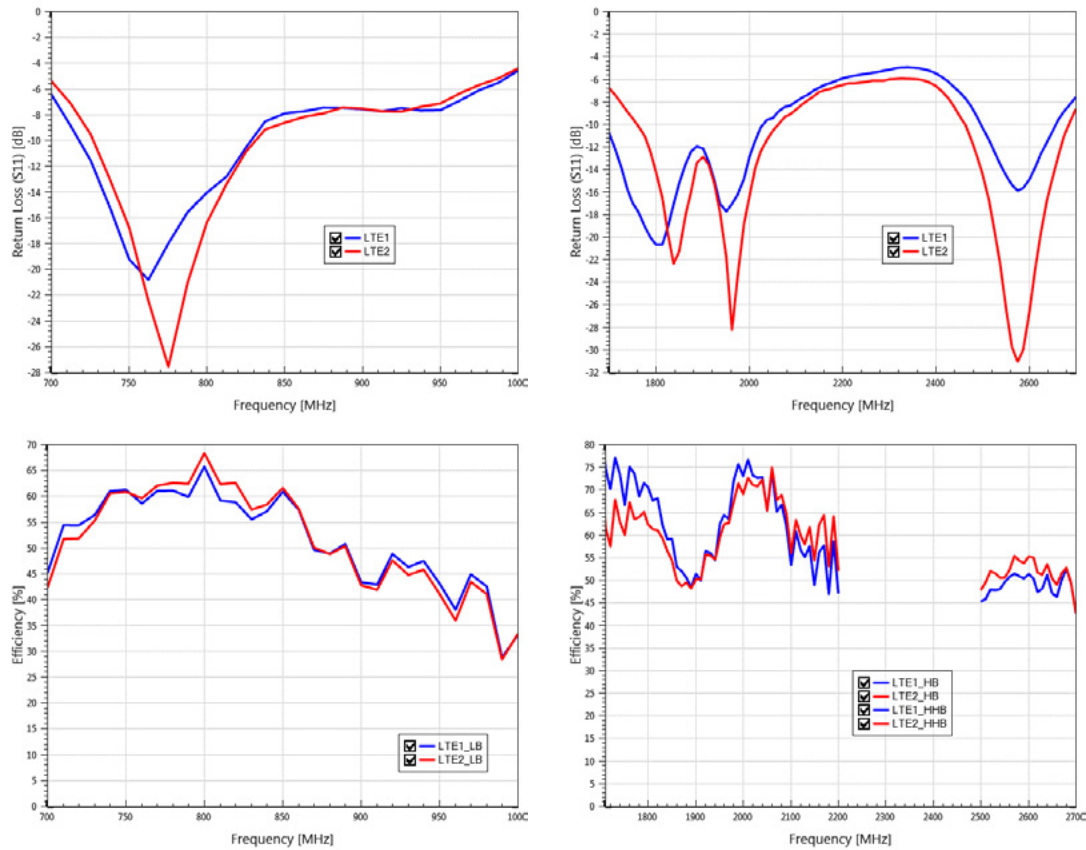
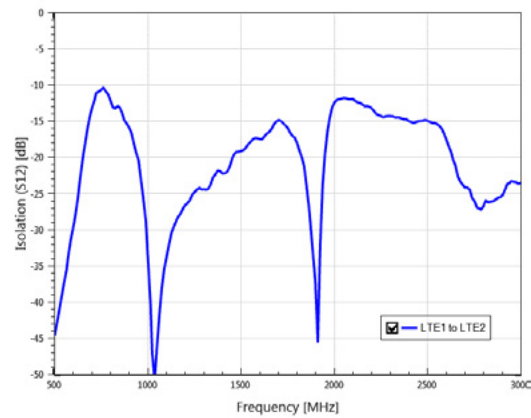
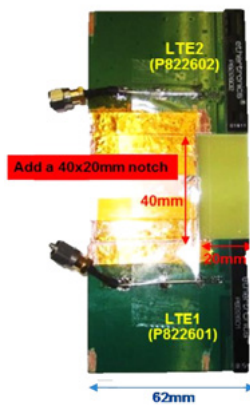

Figure 1: Both antennas on the same edge of a square board, Isolation, Return loss and Efficiency plots





# Prestta™ Octa-Band LTE/Cellular SMT Antennas

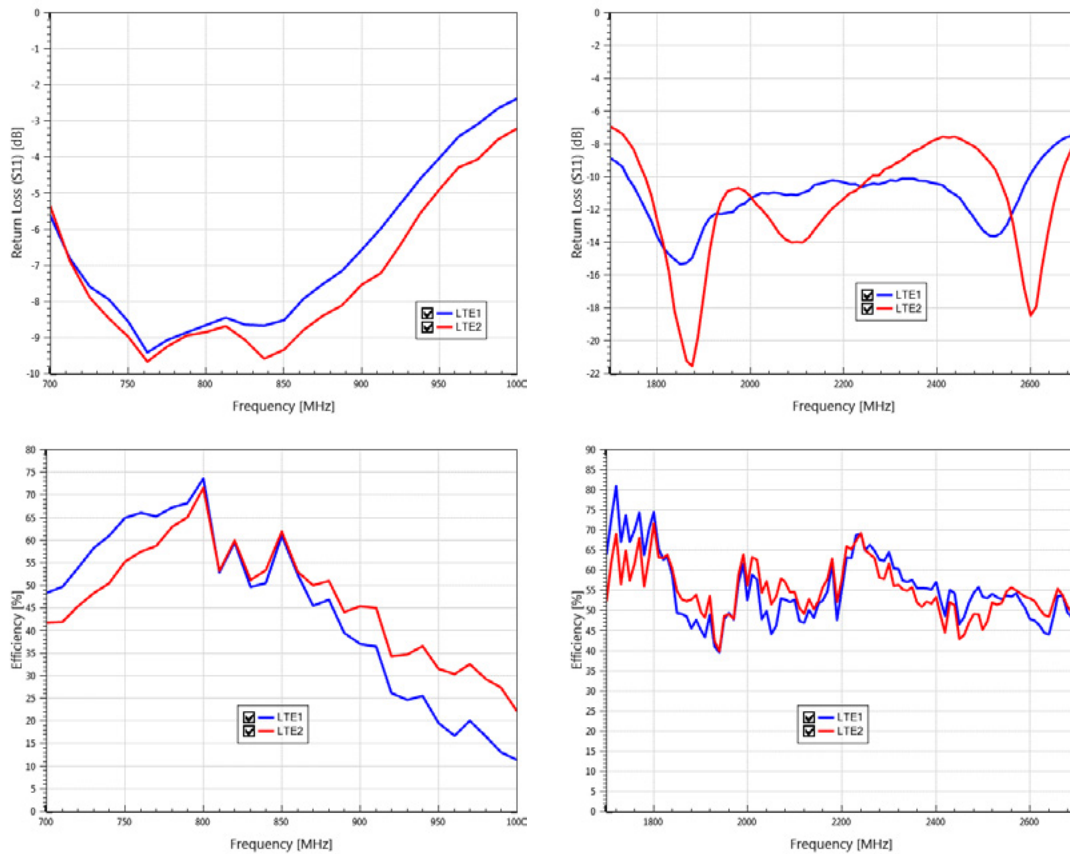
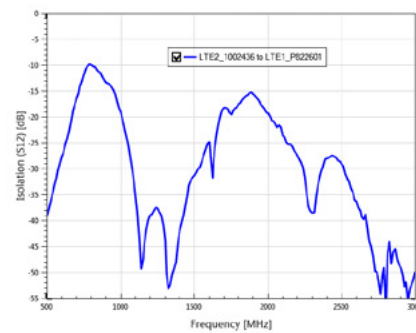
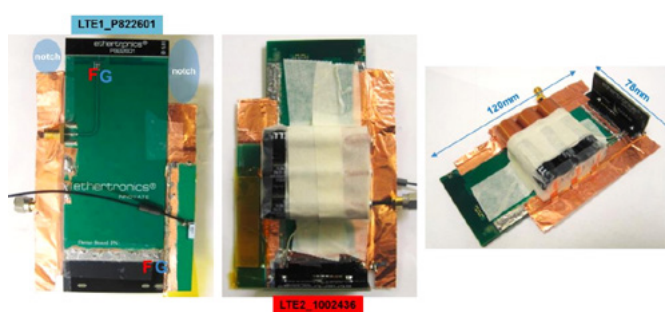

Figure 1: Both antennas on the same edge of a rectangular board, Isolation, Return loss and Efficiency plots

## Antennas Placed at the Opposite Edges of the Board

- When on narrow (<80mm) and short PCB (<130mm), The P822601 recommended MIMO configuration is in combination with KYOCERA AVX'S Vertical PCB antenna 1002436, placed parallel to the P82601, at the opposite edge of the PCB (see the Test Example 3 below).
- Notches on both sides of the P822601 are still necessary. The deeper notches are, the better antenna performances will get.

Below is an example of performances



# Prestta™ Octa-Band LTE/Cellular SMT Antennas

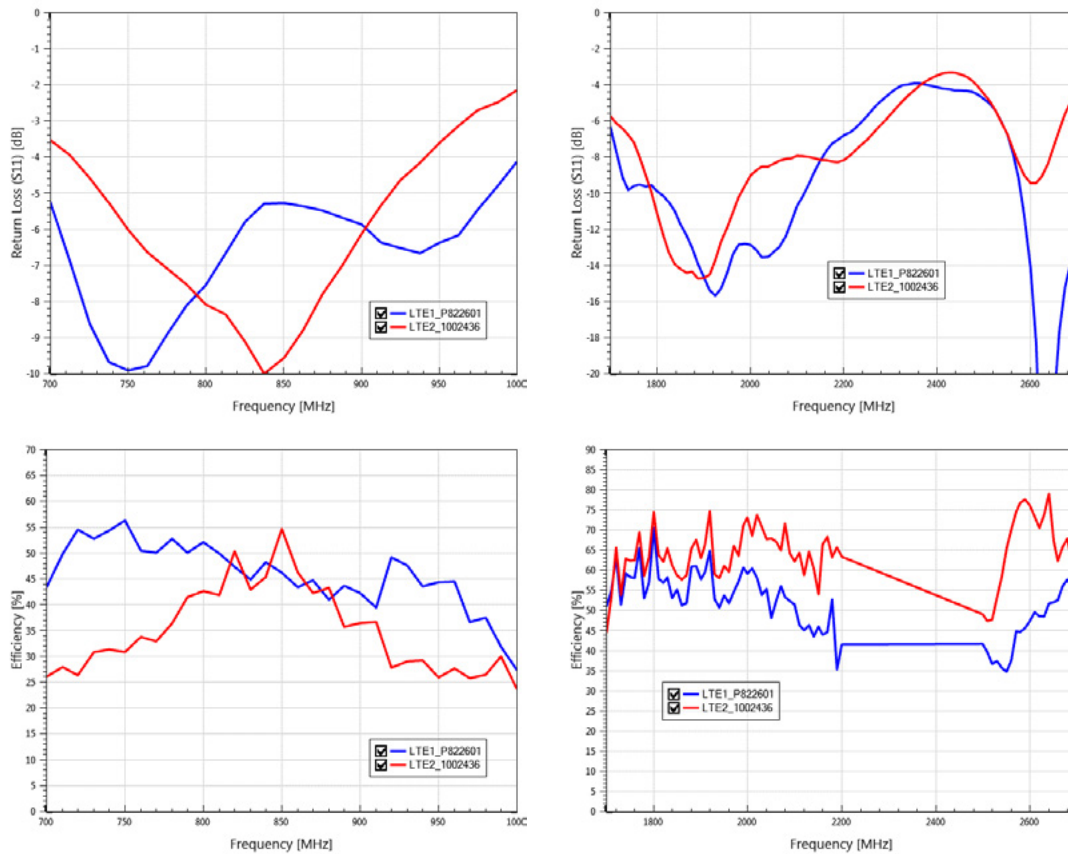

Figure 1: Both antennas on the same edge of a rectangular board, Isolation, Return loss and Efficiency plots

## Material Specifications

Item	Material
Antenna Substrate	FR4
Contact Finish	Hot Air Solder Level (HASL) or Au

## Manufacturing and Assembly Guidelines

KYOCERA AVX'S Prestta™ antennas are designed for high volume board assembly. Because different product designs use different numbers and types of devices, solder paste, and circuit boards, no single manufacturing process is best for all PCBs. The following recommendations have been determined by KYOCERA AVX, based on successful manufacturing processes.

These antennas are designed for automated pick and place surface mounting. However, as with any SMT device, KYOCERA AVX antennas can be damaged by the use of excessive force during the handling or mounting operation.

### Component Handling Recommendations

The following are some recommendations for component handling and automated mounting:

- KYOCERA AVX Standard P822601 and P822602 antennas ship and tape and tell..

KYOCERA AVX'S antennas are not moisture sensitive and the ceramic antennas meet the requirements for a Level 1 classification of J-STD-020A (moisture/reflow sensitivity classification for non-hermetic solid state surface mount devices from the Institute for Interconnecting and Packaging Electronic Circuits). Nevertheless, as a precaution to maintain the highest level of solderability, KYOCERA AVX antennas are dry-packed.

# Prestta™ Octa-Band LTE/Cellular SMT Antennas

## Paste Stencil Recommendation

KYOCERA AVX recommends application of paste stencil to a thickness of 0.1mm, applied to within 0.125mm of the solder mask surrounding each exposed metal pad on the PCB. PCB layouts for each antenna are provided in earlier section of this document.

## Soldering Recommendations

The recommended method for soldering the antenna to the board is forced convection reflow soldering. The following suggestions provide information on how to optimize the reflow process for the antenna:

Adjust the reflow duration to create good solder joints without raising the antenna temperature beyond the allowed maximum of 260° C.

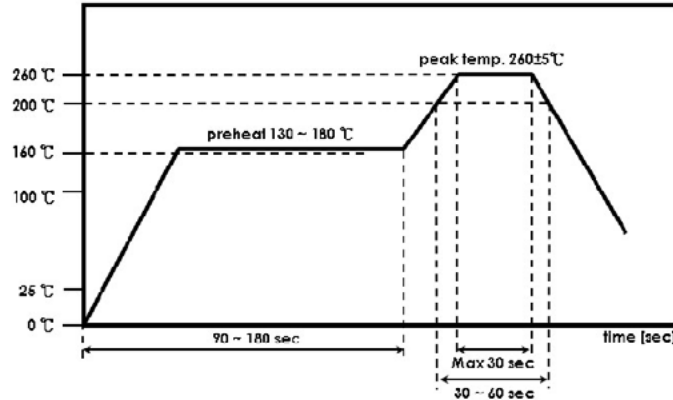

## Additional Manufacturing Recommendations

Care should be taken during certain customer-specific manufacturing processes including PCB separation and Ultrasonic Welding to ensure these processes don't create damage to the components

## Cleaning Recommendations

After the soldering process, a simple wash with deionized water sufficiently removes most residues from the PCB. Most board assembly manufacturers use either water-soluble fluxes with water wash, or "no clean" fluxes that do not require cleaning after reflow.

**Acceptable cleaning solvents** are CFC alternatives, Isopropyl Alcohol (IPA), and water. If the application uses other types of solvents, please consult with KYOCERA AVX.

**Cleaning processes that should be avoided** are ultrasonic cleaning and any abrasive techniques, such as scrubbing with a cotton swab or with an abrasive material.

## Rework & Removal Recommendations

There may be a need to rework or remove the antenna from the PCB. Although KYOCERA AVX'S antennas are designed for ease-of-use, use care when separating them from the PCBs. Careless heating or removal of the antenna can cause thermal, mechanical or lead damage. These degradations may render the antenna useless, impeding any failure analysis and preventing the reuse of the device. Therefore it is recommended to observe the following precautions:

- The component can be reworked and soldered by hand using a soldering iron. However care should be used so the temperature does not exceed 260°C. The soldering iron should not touch the composite material while soldering the leads of the antenna.
- The component can be reworked and soldered using a hot air rework station. However, care should be taken to ensure that the temperature does not exceed 260°C.
- Once the solder on the PCB is sufficiently heated, use a vacuum pen to lift the antenna straight up off the PCB. Avoid twisting or rotating the device while removing it.

## Tape & Reel Specifications

Product will be shipped in Tape and Reel packaging.

Product specifications subject to change without notice.





**FOLLOW US:**     

VISIT US AT [WWW.KYOCERA-AVX.COM](http://WWW.KYOCERA-AVX.COM) 

 +1 (864) 967-2150

 [ETH.INFO@KYOCERA-AVX.COM](mailto:ETH.INFO@KYOCERA-AVX.COM)